

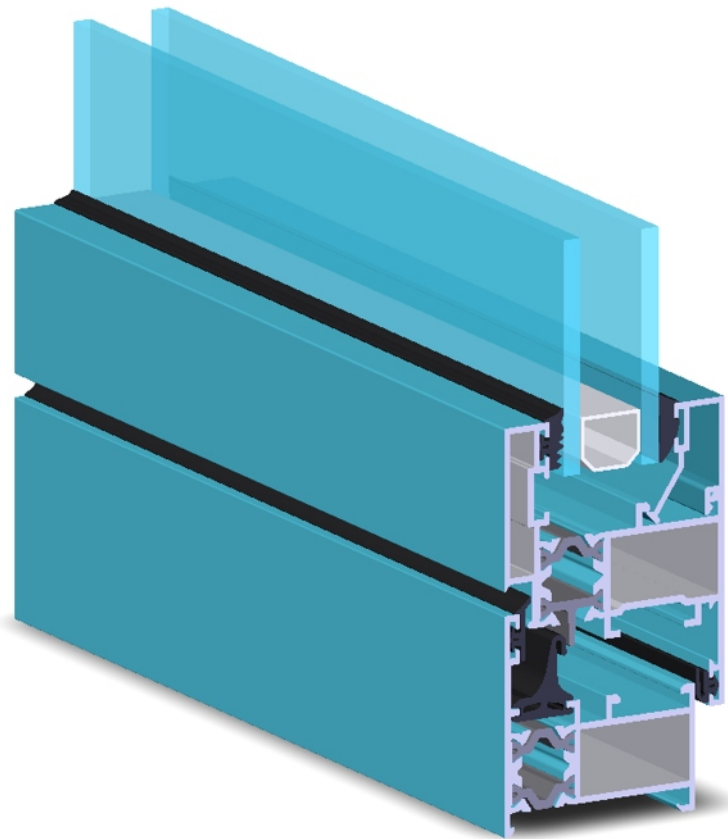

**alesil**  
ALUMÍNIOS



RT 45

## SÉRIE RT 45

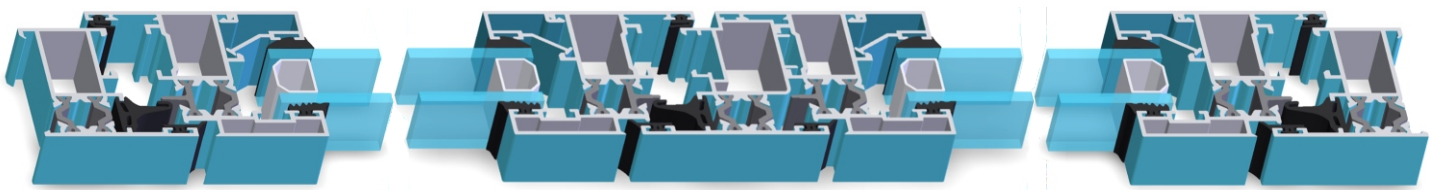



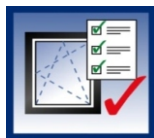

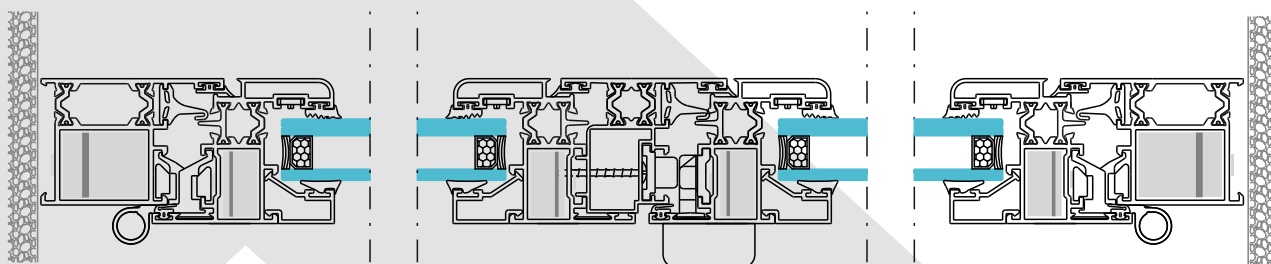

SISTEMA DE BATENTE COM 45MM  
CÂMARA EUROPEIA COM RUPTURA TÉRMICA

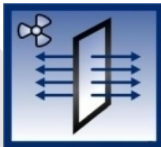

NORMA EN 14351-1:2006



	Vão Dimensão L x H	Oscilo-Batente 2 fls 1230 x 1480	Porta 2 fls 1500 x 2200
		Vidro Utilizado 4 / 12 / 4	
	Permeabilidade ao Ar (UN-EN 1026:2000)	Classe 4 Certificado 173646	Classe 4 Certificado 173645
	Permeabilidade à Água (UN-EN 1027:2000)	Classe 9A Certificado 173646	Classe E750 Certificado 173645
	Resistência ao Vento (UN-EN 12211:2000)	Classe C5 Certificado 173646	Classe C2 Certificado 173645
	Transmissão Térmica (UN-EN 12567-1:2002) $U_{s,t}$ ( $U_w$ )	3,3 w / (m <sup>2</sup> k) Certificado 173648	3,3 w / (m <sup>2</sup> k) Certificado 173648
	Atenuação Acústica (UN-EN 140-3:1995) $R_w$ (C;Ctr)	33 (-2; -5) db Certificado 173647	33 (-2; -5) db Certificado 173647
	Mecanismo de Segurança (UN-EN 14609:2004) Cargas	Apto 350 N Certificado 173649	Apto 350 N Certificado 173649

# RT 45

PT-02

Aro Fixo de Janela

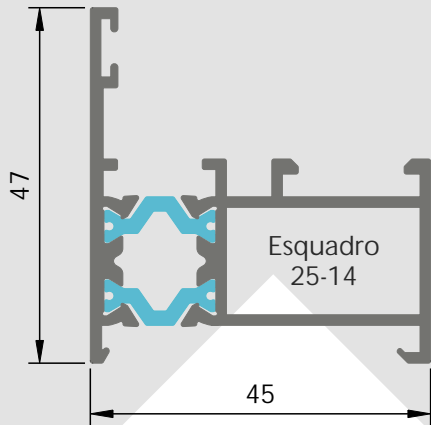

PT-09

Aro Fixo de Porta

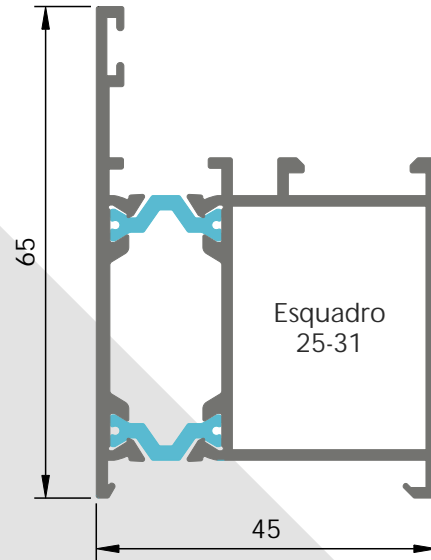

PT-28

Aro Fixo com Remate

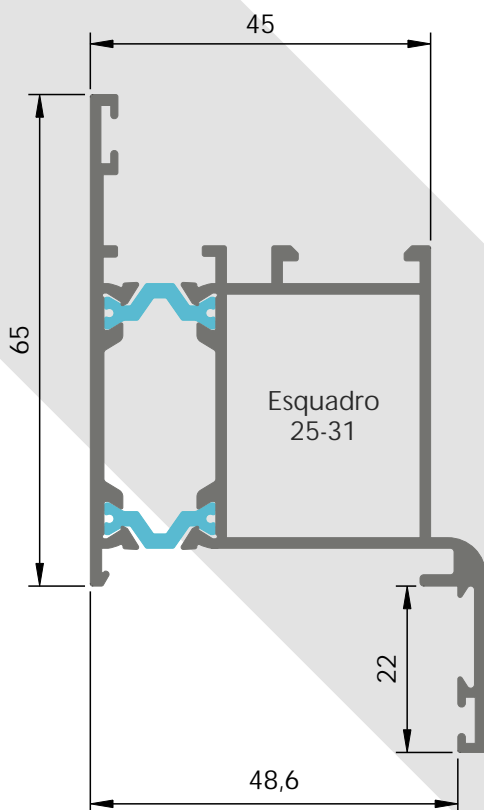

PT-90

Aro Fixo c/ Apainelado / Condensação

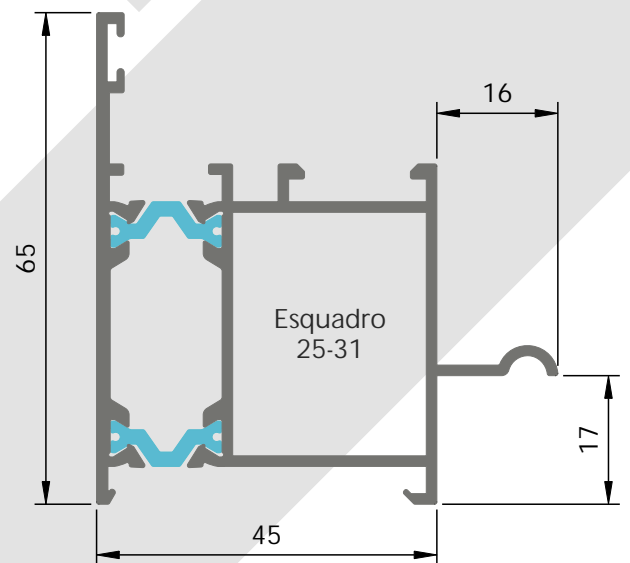

# RT 45

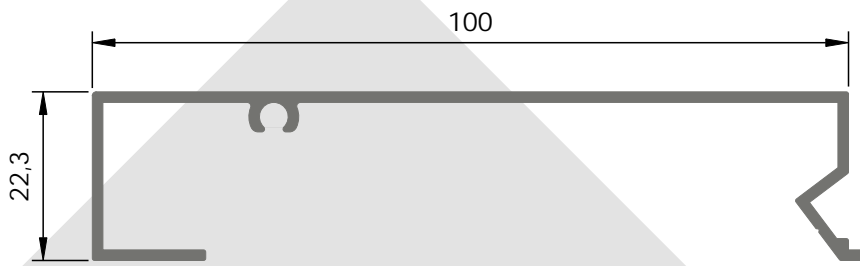

1063  
Perfil de Remate

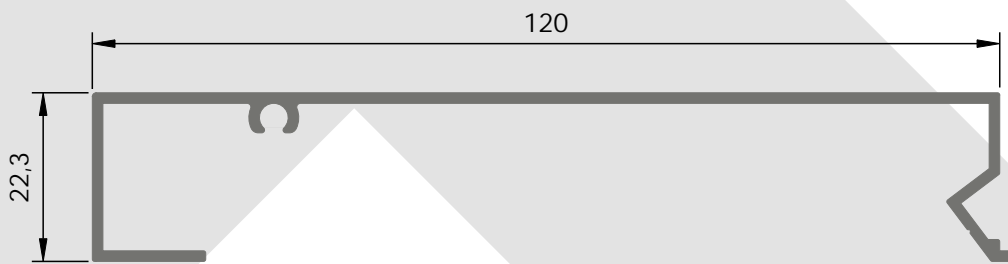

1064  
Perfil de Remate

1001  
Perfil de Remate

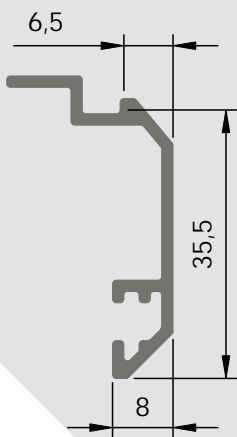

1006  
Clip para Perfis de Remate



1007  
Perfil de Remate

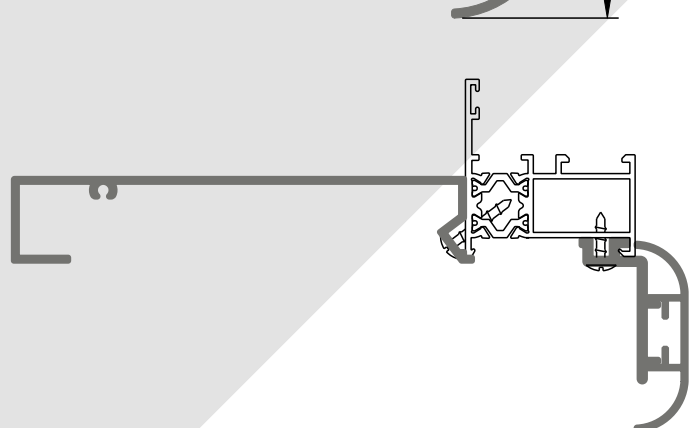
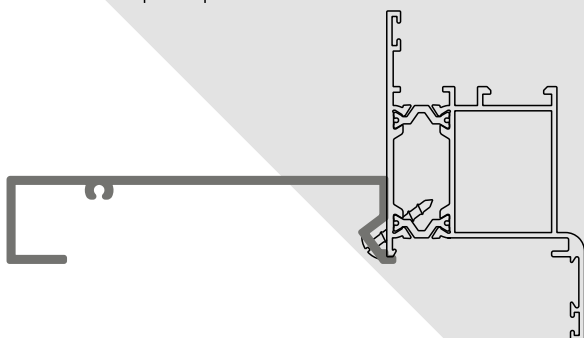
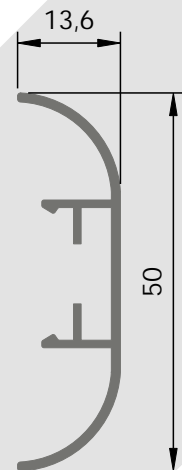

# RT 45

## PT-25

Aro Fixo Rústico de Janela

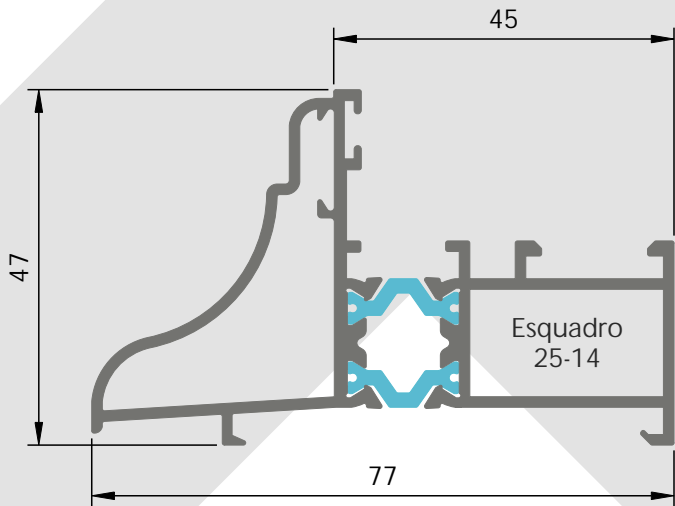

## PT-24

Aro Fixo Rústico de Porta

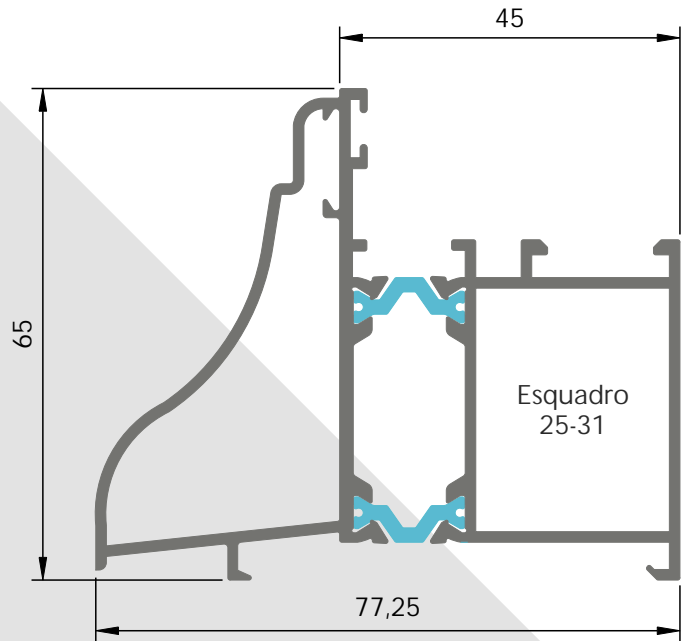

## PT-29

Aro Fixo Rústico com Remate

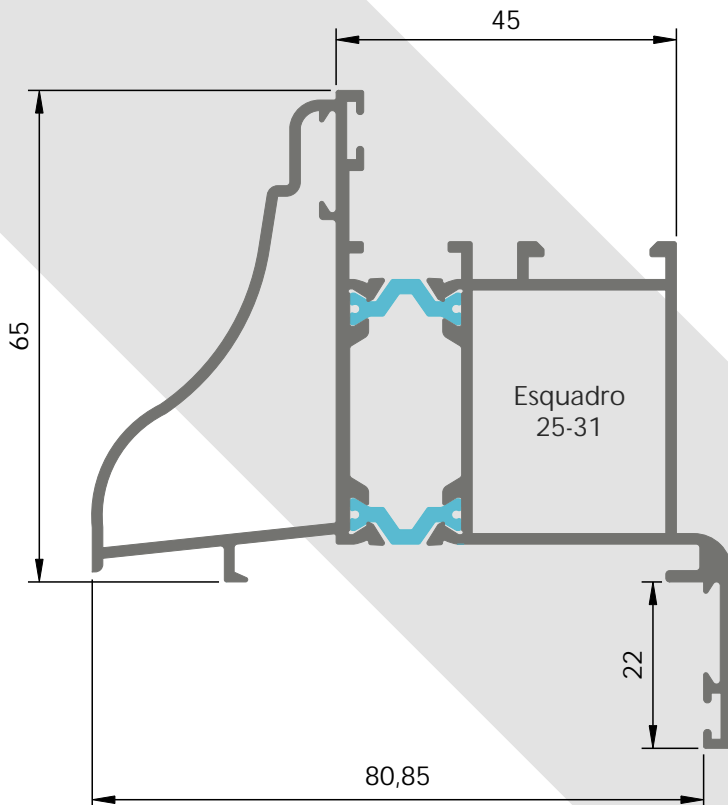

## PT-290

Aro Fixo Rústico  
c/ Apainelado / Condensação

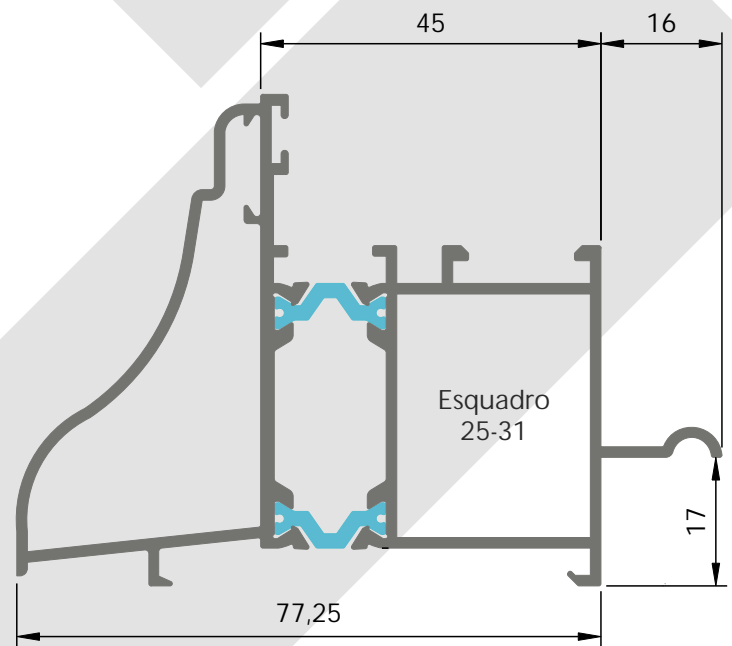

# RT 45

## PT-14

Perfil de Ligação

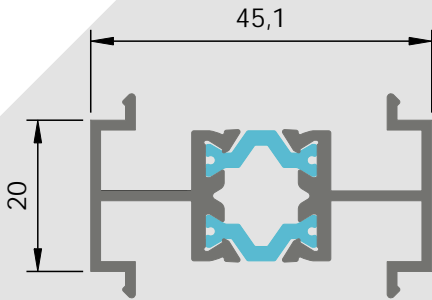

## PT-40

Soleira de Condensação

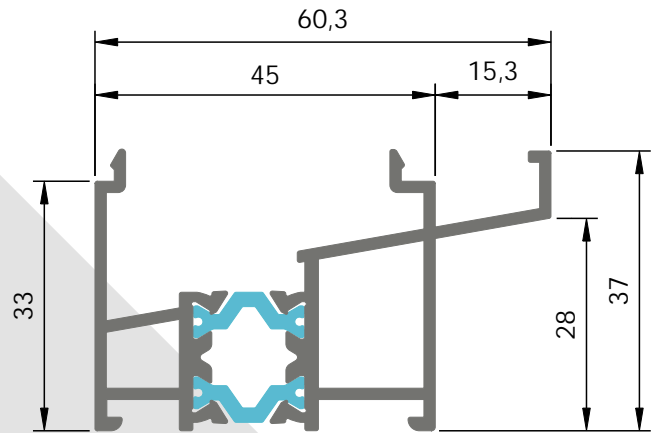

## PT-05

Soleira de Condensação com Aba 20mm

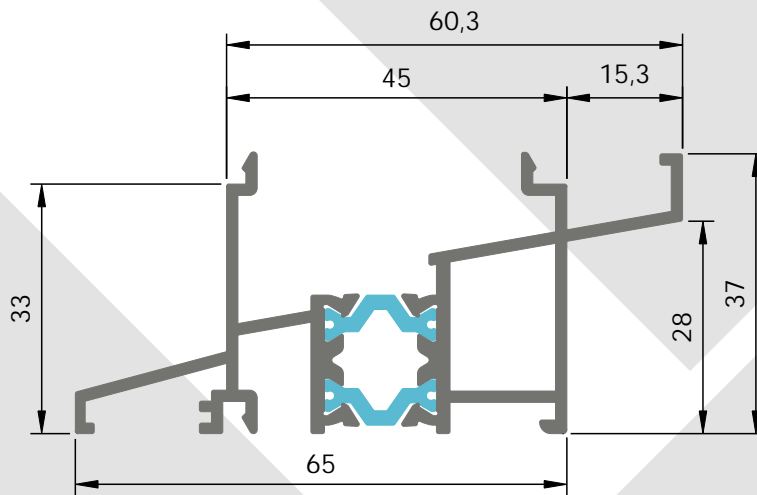

## PT-05L

Soleira de Condensação com Aba 76mm

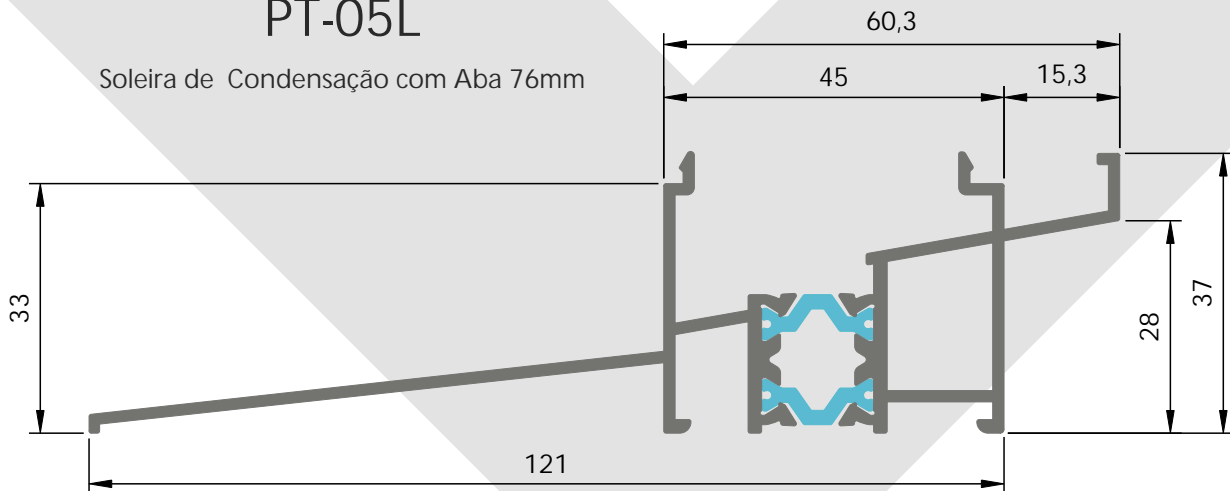

# RT 45

PT-01

Travessa Estreita

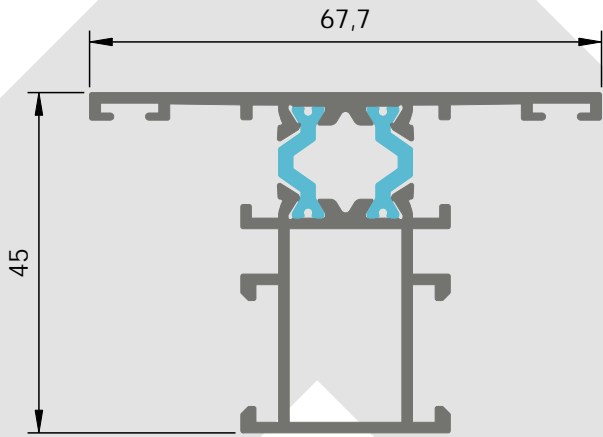

PT-08

Travessa Larga

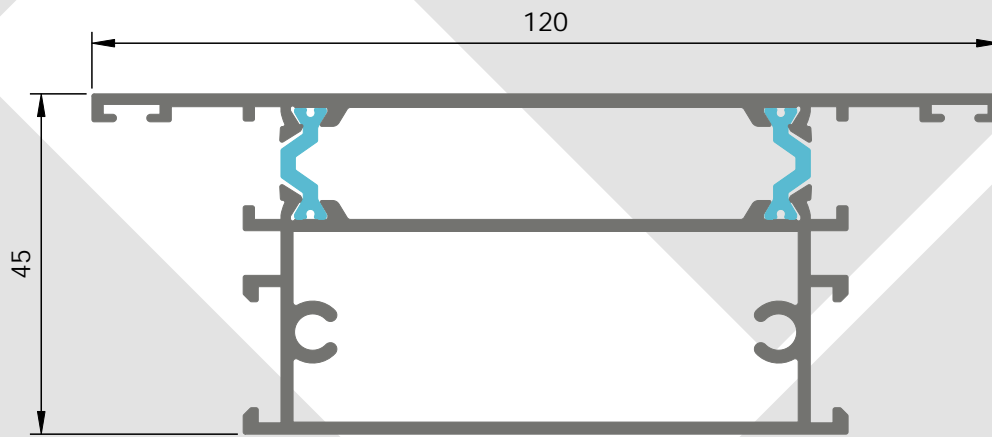
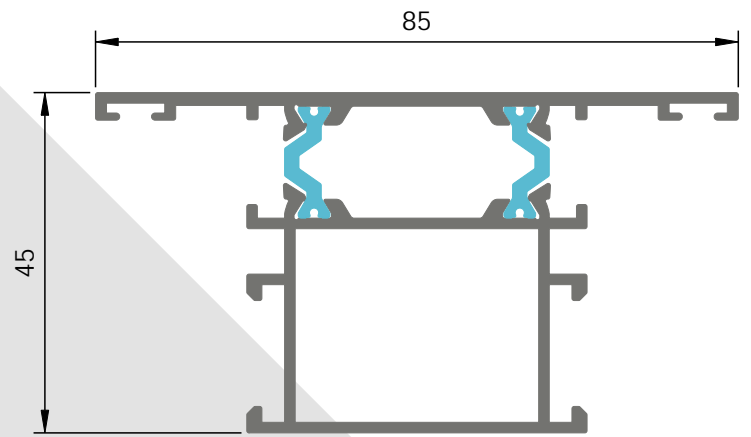

PT-17

Almofada

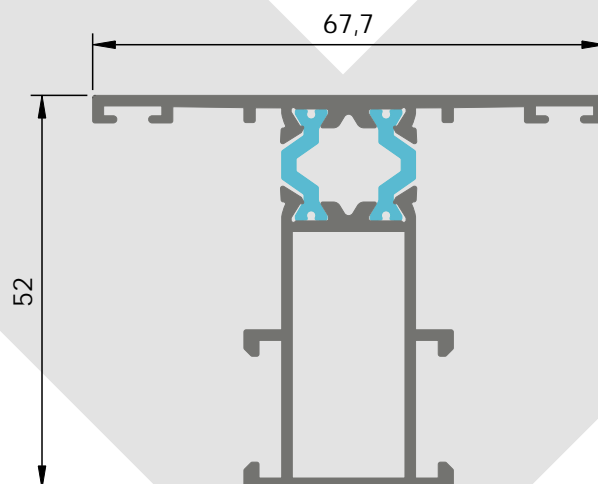

PT-07

Travessa Estreita p/ Móvel  
PT-04 e PT10

# RT 45

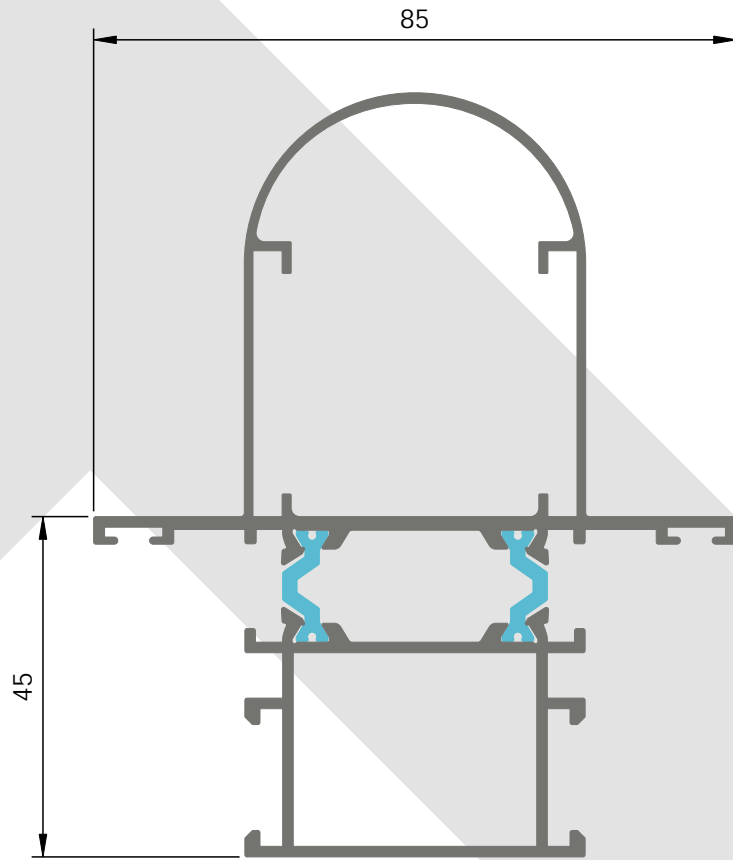

PT-16  
Montante Reforçado

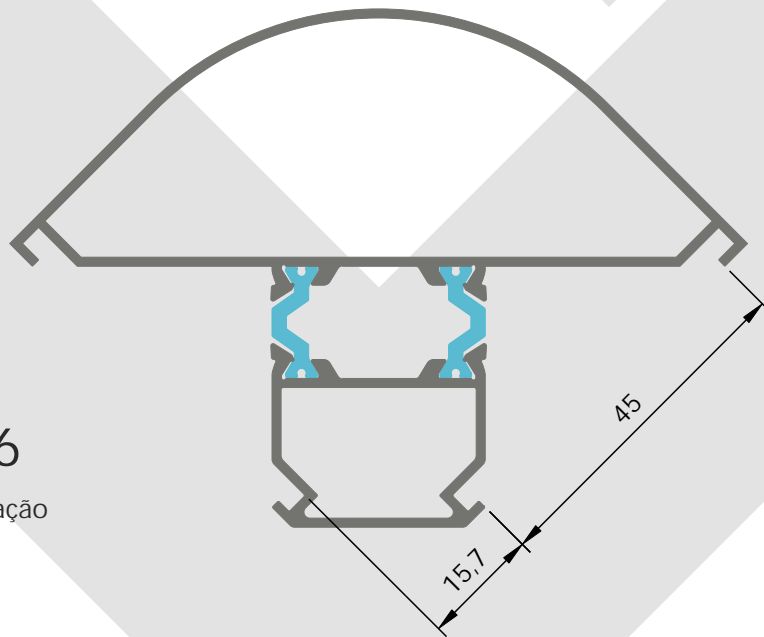

BXI-26  
Canto de Ligação



# RT 45

PT-06 N

Aro Móvel de Janela

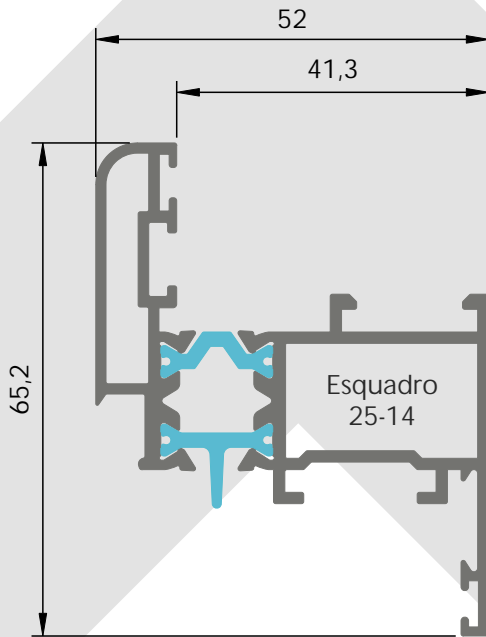

PT-42

Aro Móvel de Janela

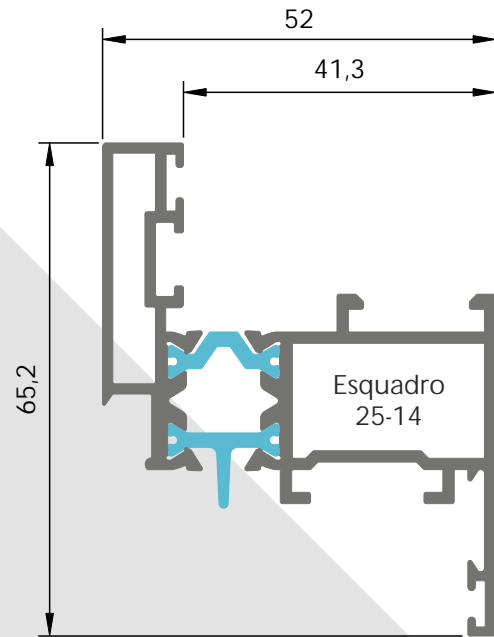

PT-15 N

Aro Móvel de Porta

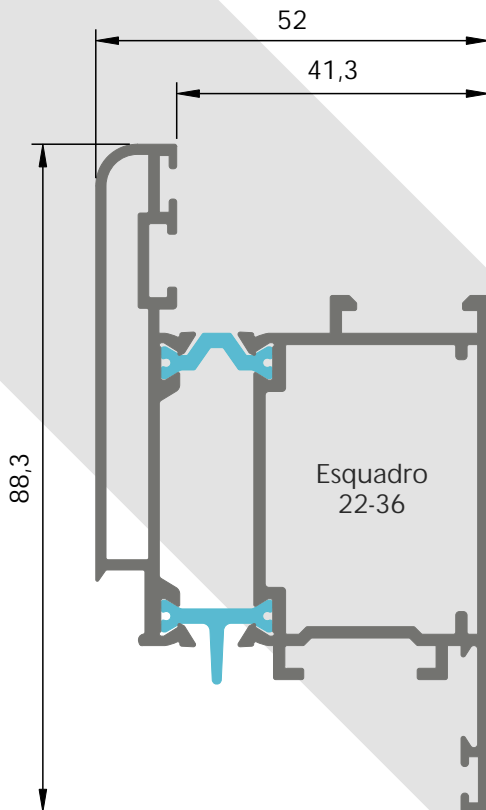

PT-43

Aro Móvel de Porta

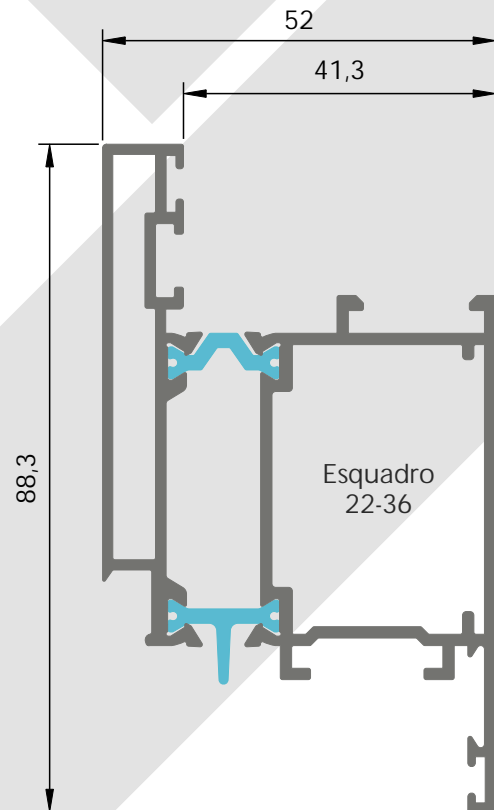

# RT 45

PT-26

Aro Móvel de Janela

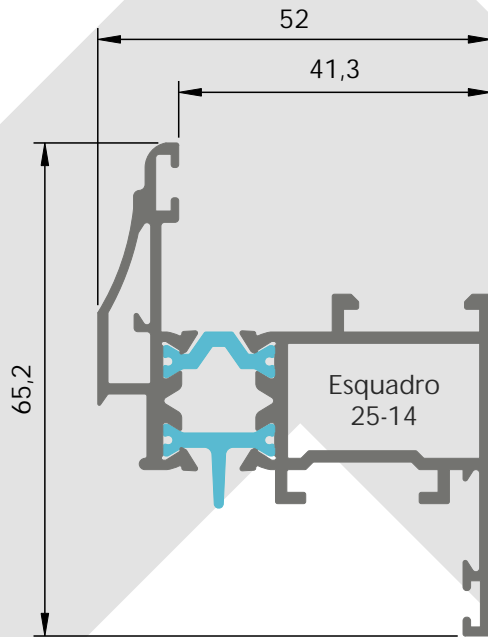

PT-04

Aro Móvel de Janela

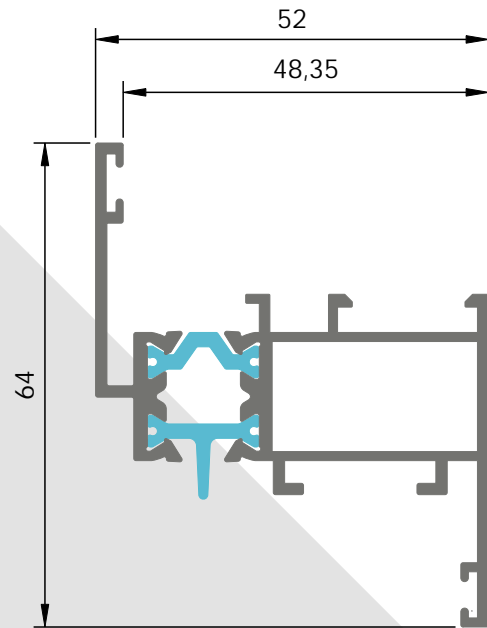

PT-27

Aro Móvel de Porta

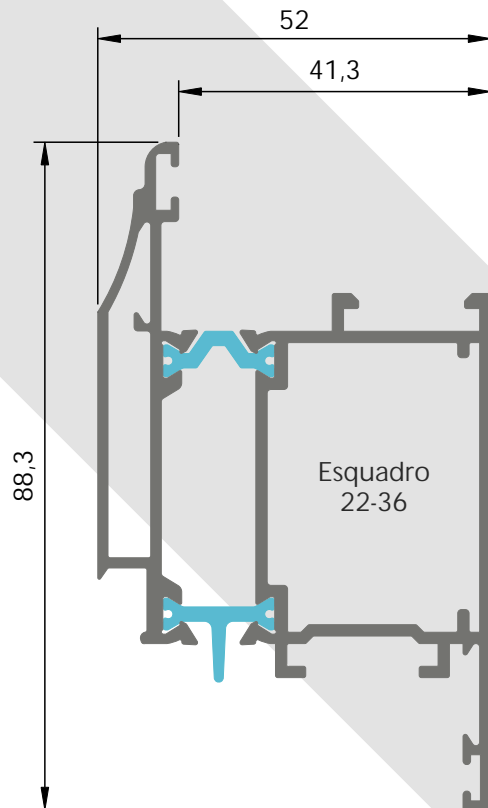

PT-10

Aro Móvel de Porta

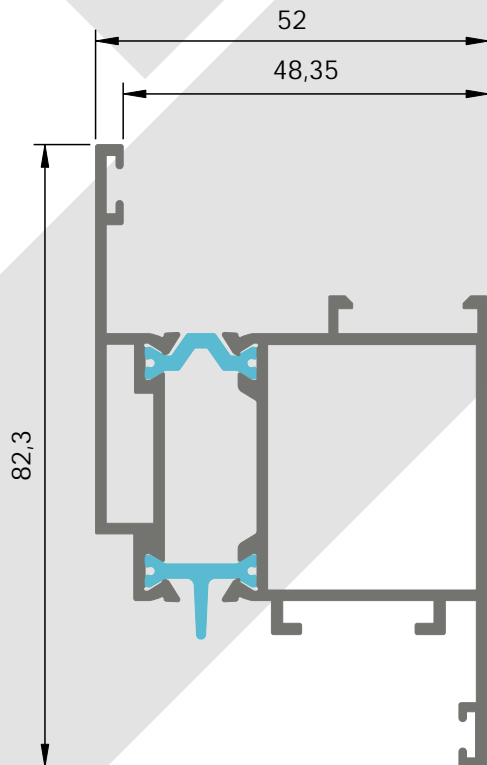

# RT 45

PT-45

Aro Móvel de Abertura Exterior

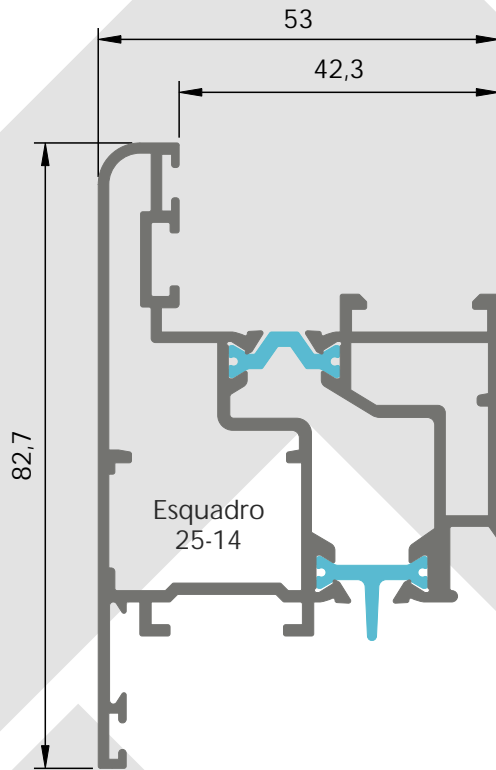

PT-41

Aro Móvel de Abertura Exterior

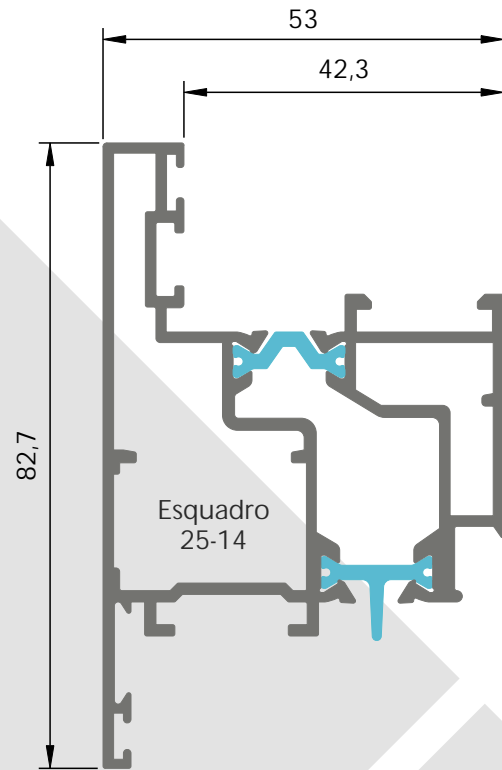

PT-34

Aro Móvel de Pivotante

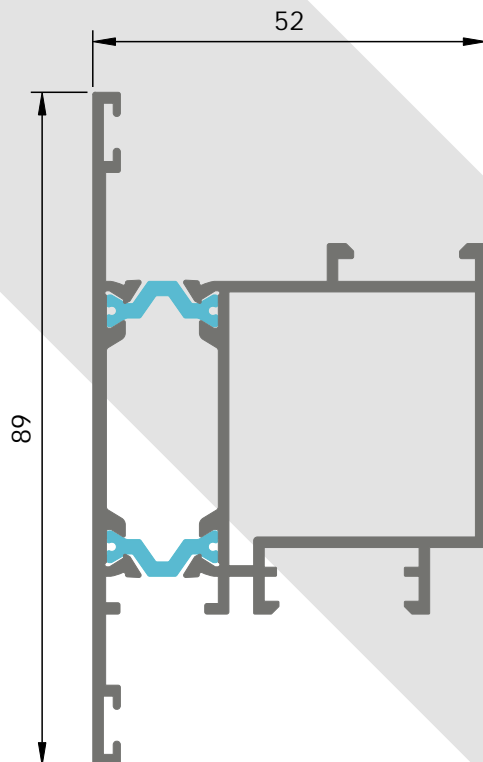

PT-53

Postiço Pivotante

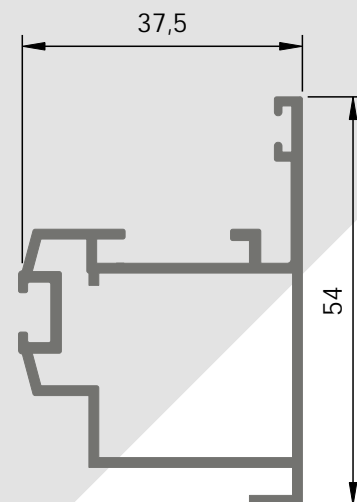

# RT 45

## PT-3 C

Inversor

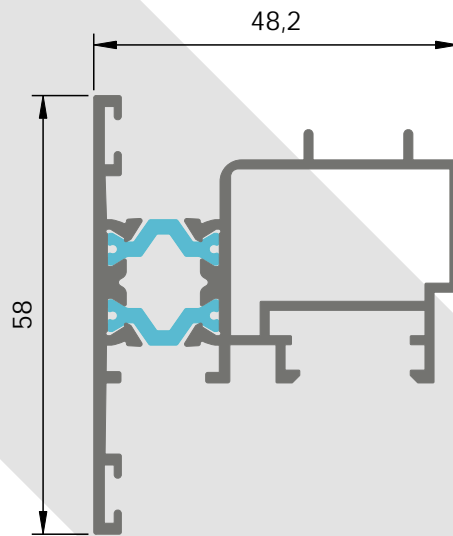

## PT-44

Chapa Dulpa

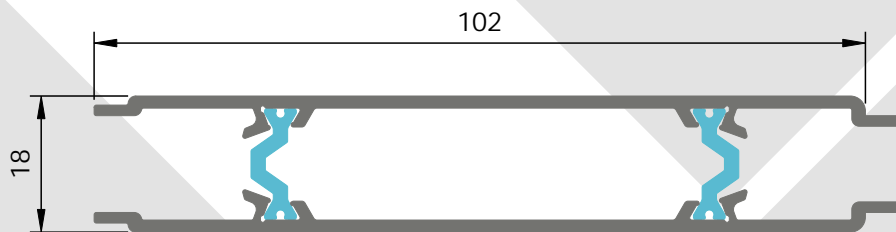

## N 12096

Pingadeira

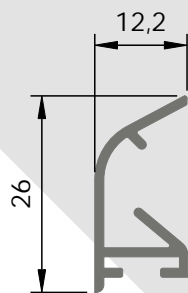

## N 12097

Clip Pingadeira

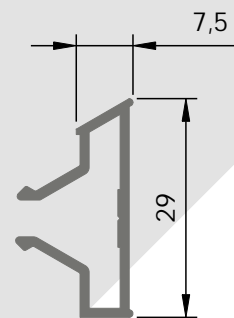

# RT 45

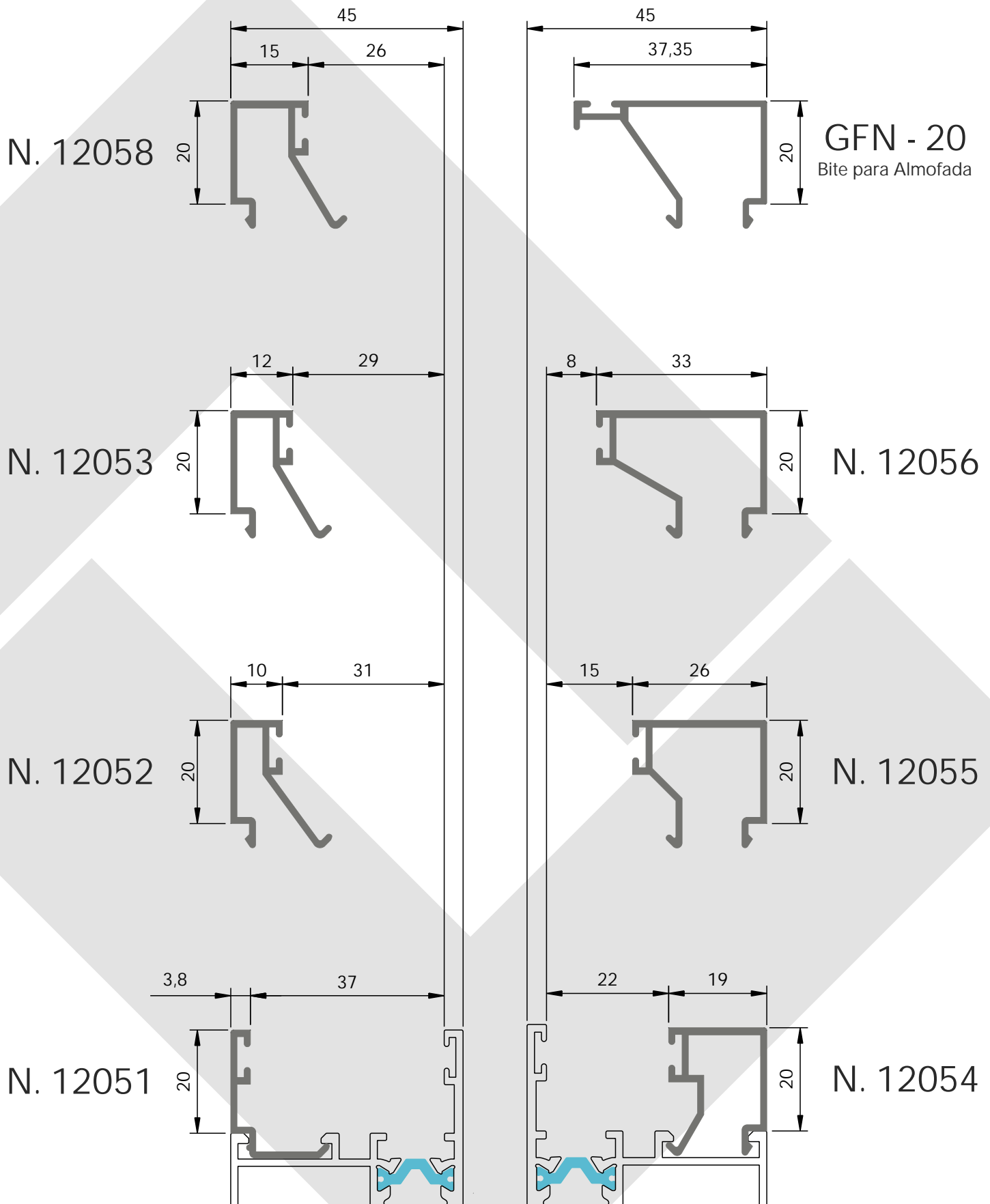

# RT 45

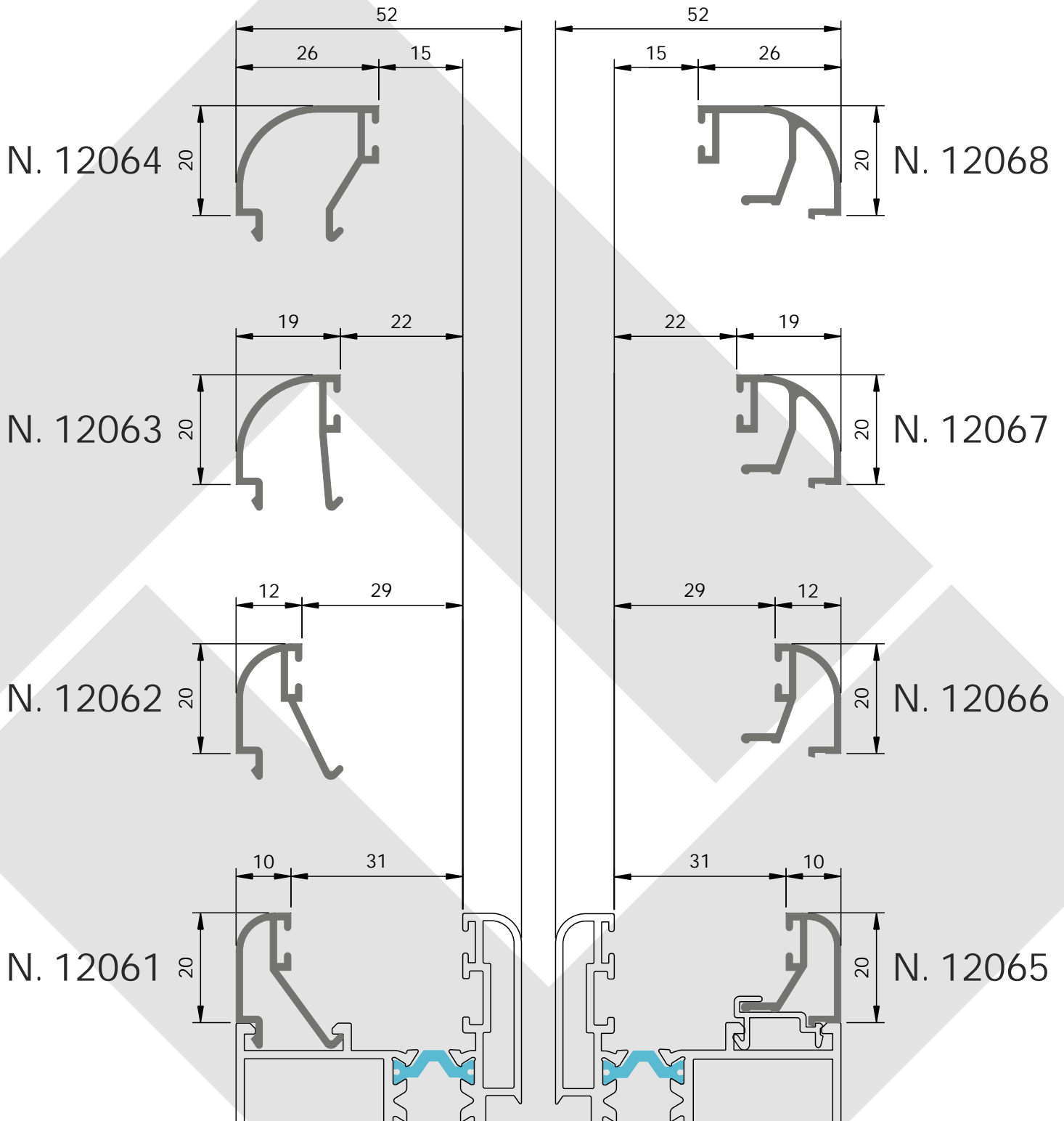

N12091  
Mola de Bite



## SOLUÇÕES POSSÍVEIS DE ABERTURAS

Abrir de 1 Folha

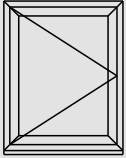

Abrir de 2 Folhas

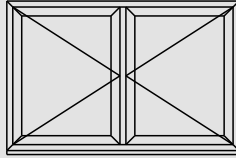

Abrir de 3 Folhas

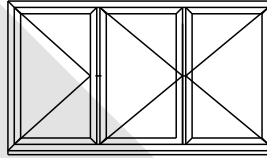

Abrir de 4 Folhas

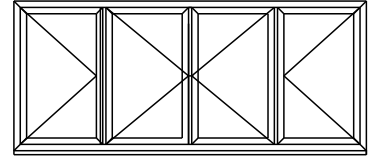

Oscilo-Batente de 1 Folha

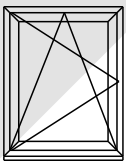

Oscilo-Batente de 2 Folhas

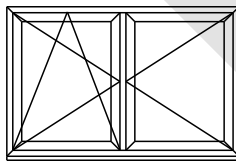

Oscilo-Batente de 3 Folhas

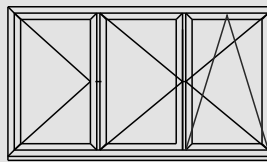

Oscilo-Batente de 4 Folhas

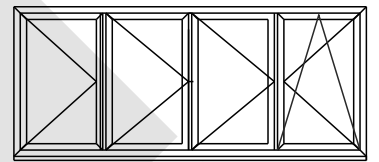

Porta de 1 Folha

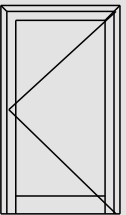

Porta de 2 Folhas

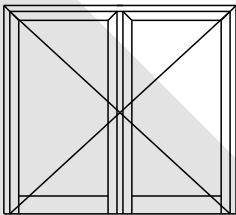

Porta de 3 Folhas

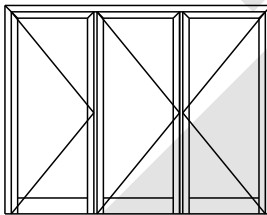

Porta de 4 Folhas

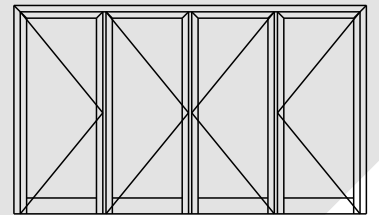

Fixo

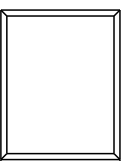

Basculante

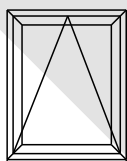

Pivotante

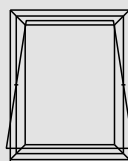

Janela Mista  
Fixo + Janela de Abrir

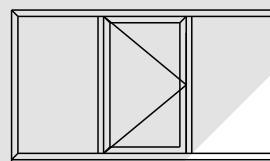

Janela Mista  
Fixo + Oscilo-Batente

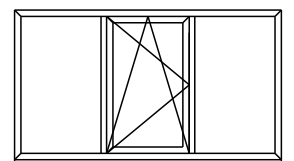

# RT 45

## PORMENORES DE MONTAGEM

### JANELA DE 2 FOLHAS

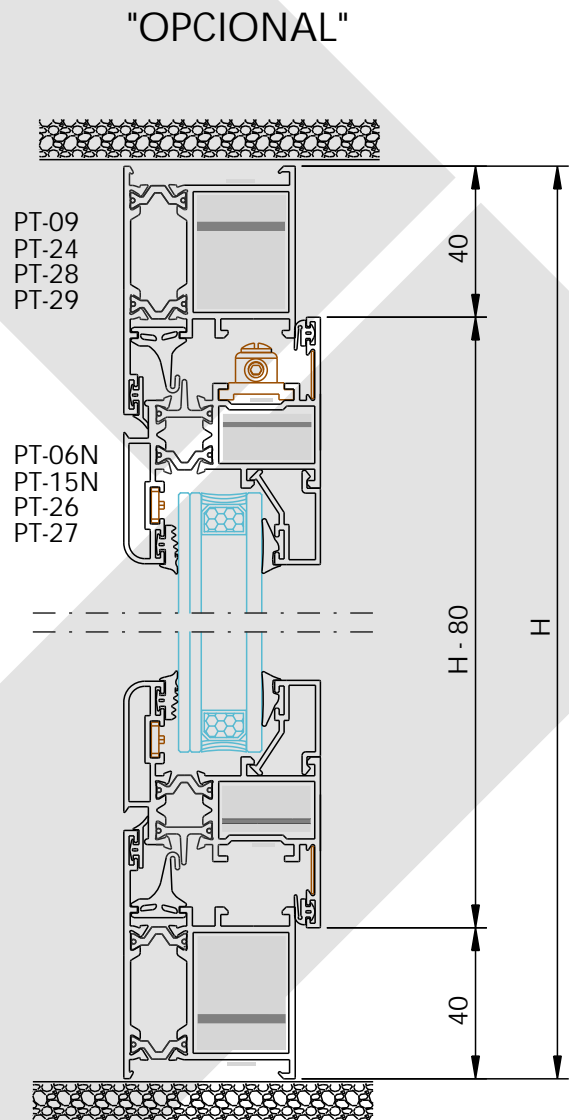
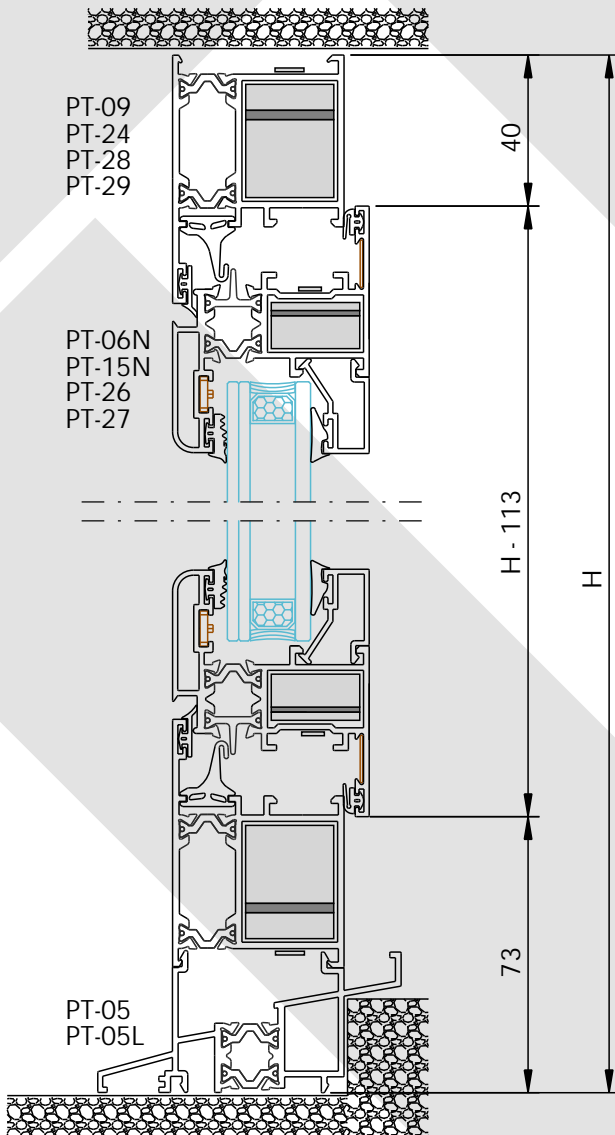
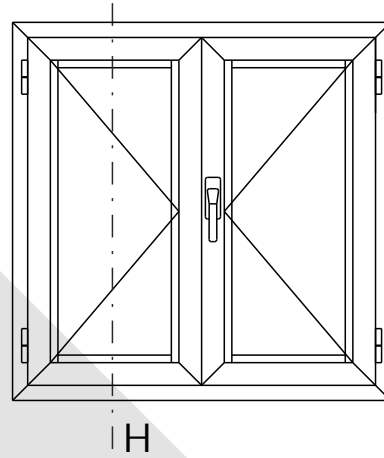
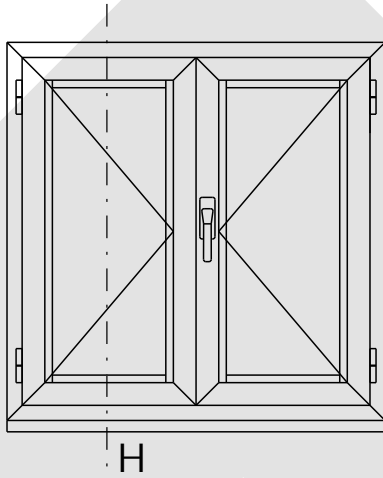

Estas medidas de corte são de carácter informativo

Escala 1:2



# RT 45

## PORMENORES DE MONTAGEM

### JANELA DE 2 FOLHAS

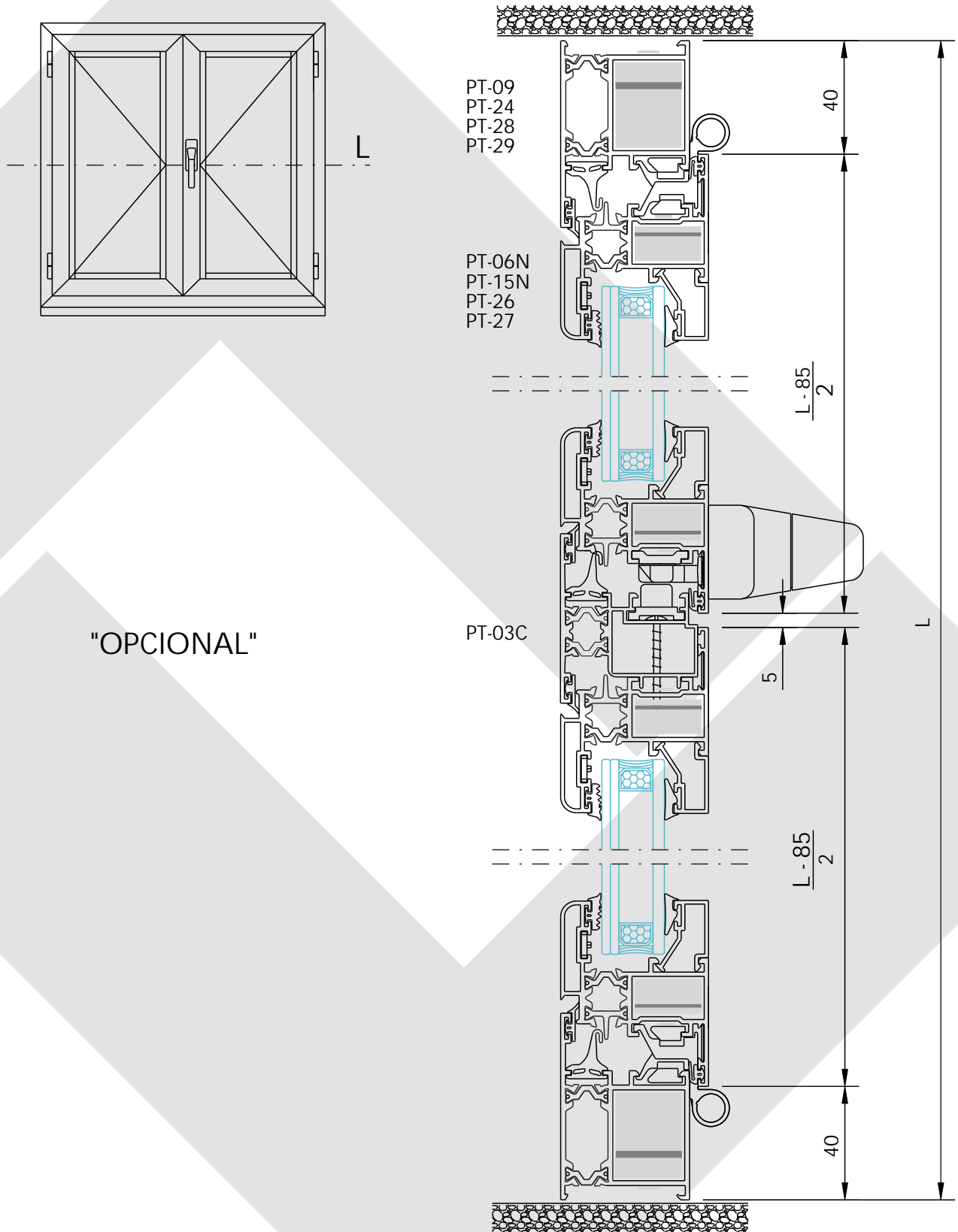

"OPCIONAL"

Escala 1:2

Estas medidas de corte são de carácter informativo

# RT 45

## PORMENORES DE MONTAGEM

### JANELA DE 3 FOLHAS

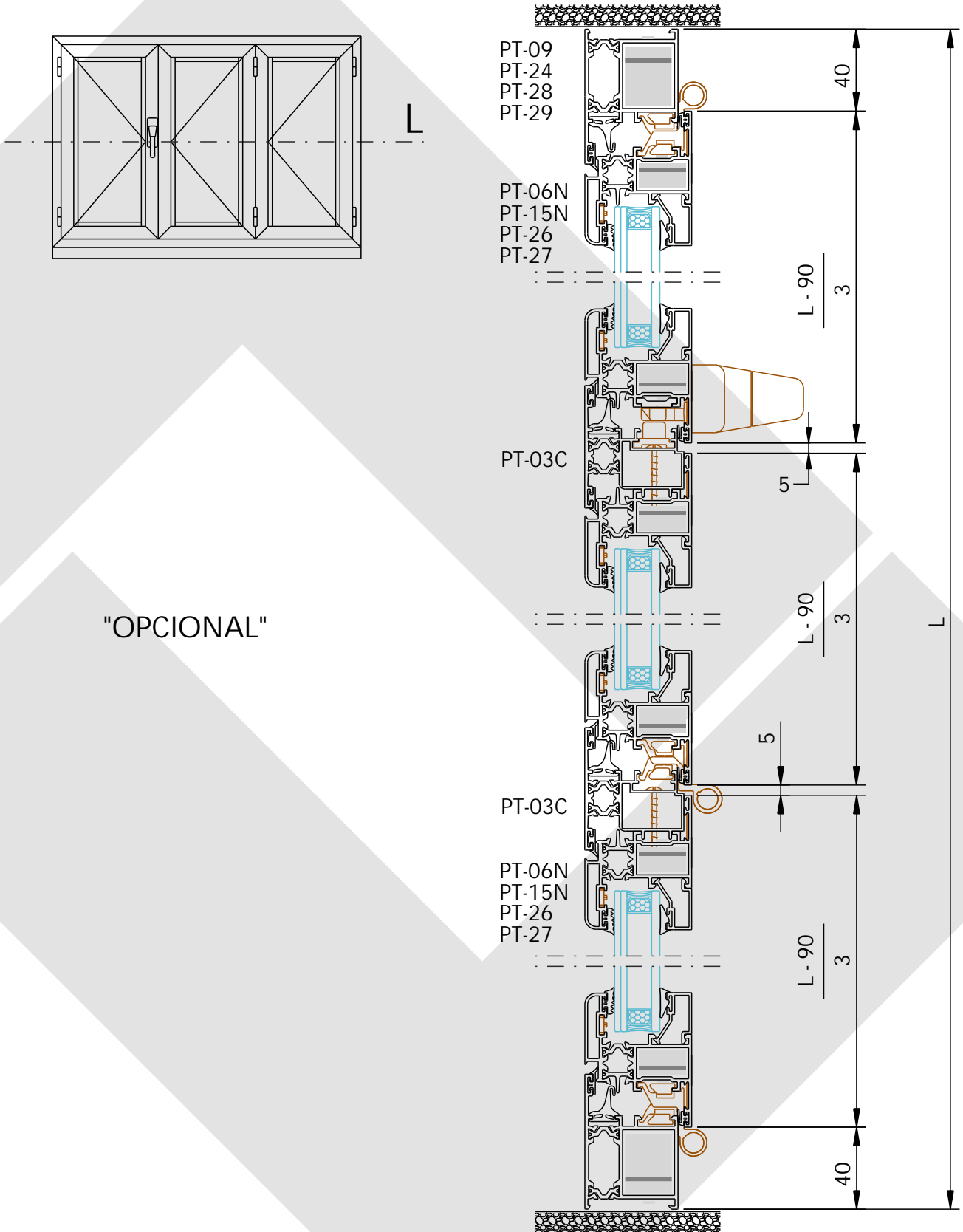

Estas medidas de corte são de carácter informativo

Sem Escala

# RT 45

## PORMENORES DE MONTAGEM

### JANELA DE 4 FOLHAS

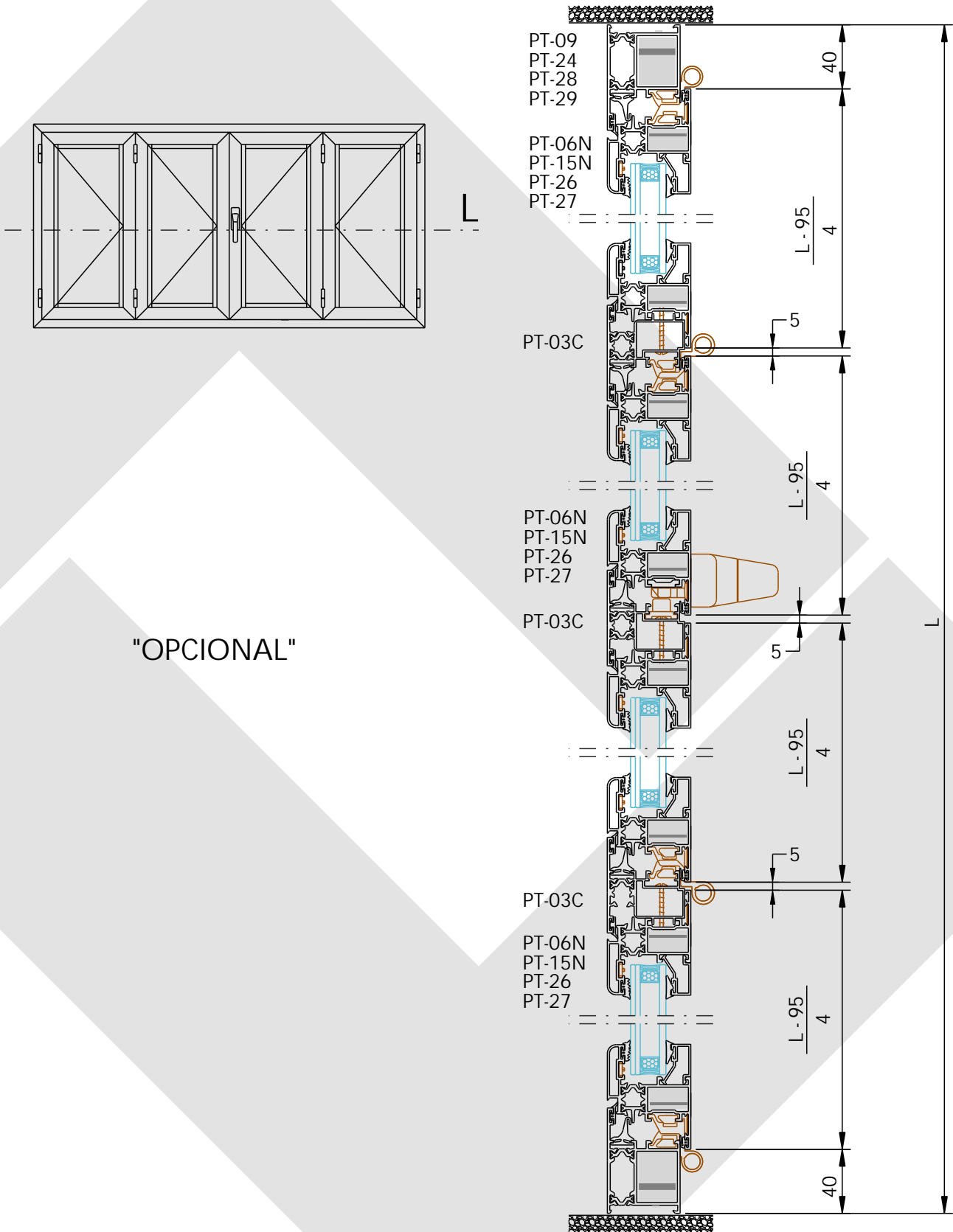

Sem Escala

Estas medidas de corte são de carácter informativo

ed. 001

# RT 45

## PORMENORES DE MONTAGEM

PORTA DE 1 FOLHA

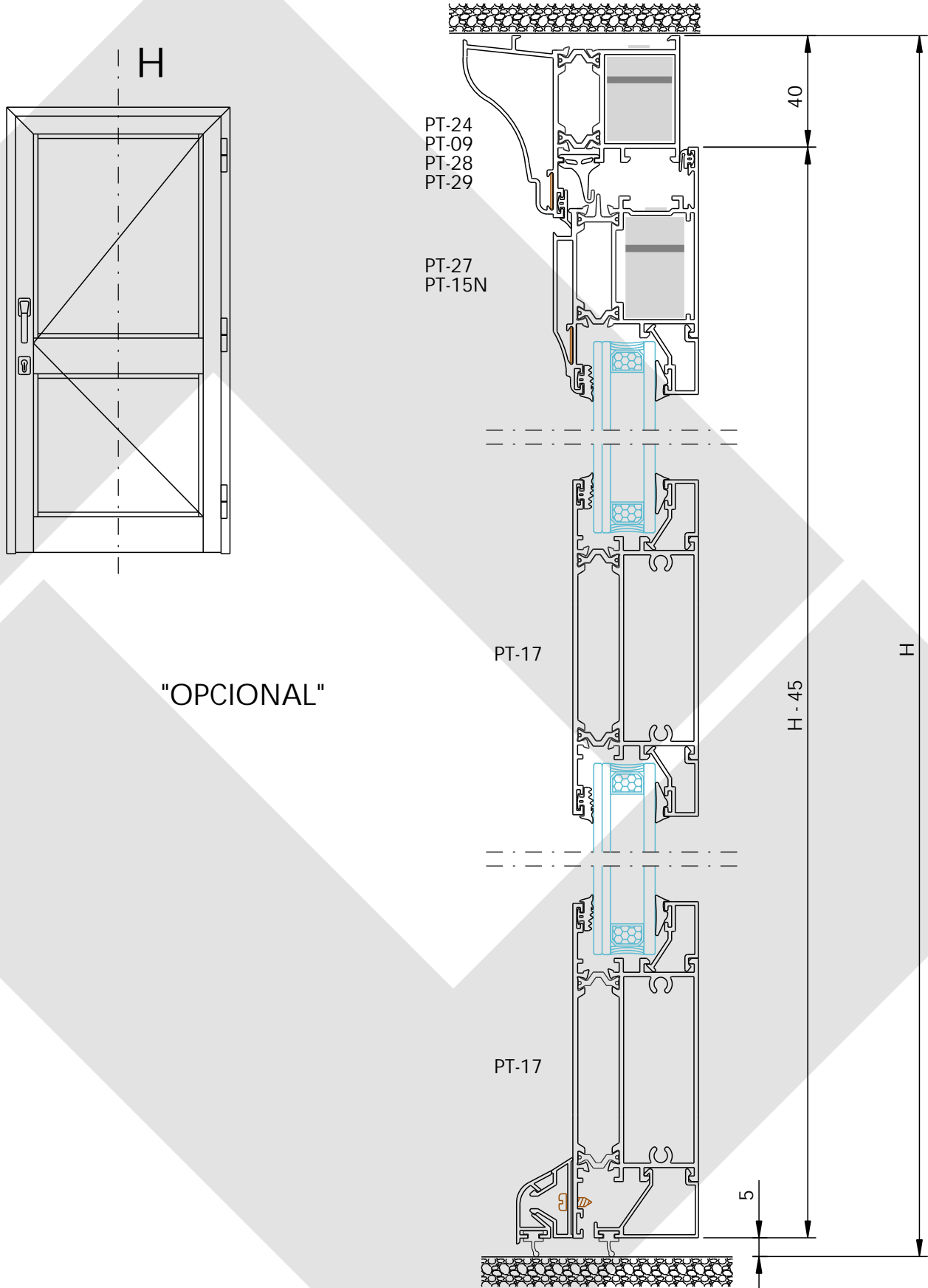

Estas medidas de corte são de carácter informativo

Escala 1:2

# RT 45

## PORMENORES DE MONTAGEM

PORTA DE 1 FOLHA

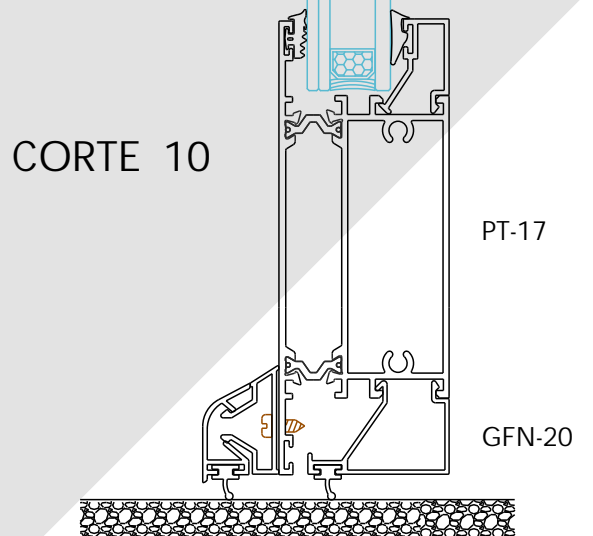
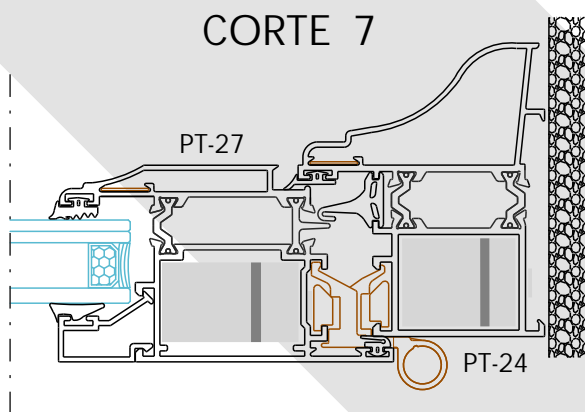
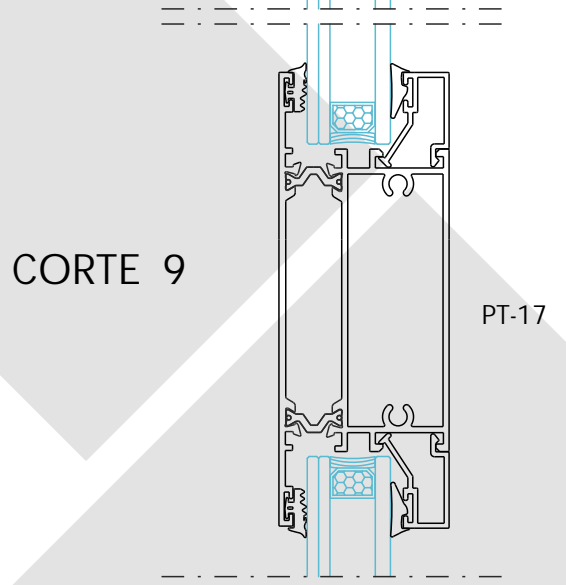
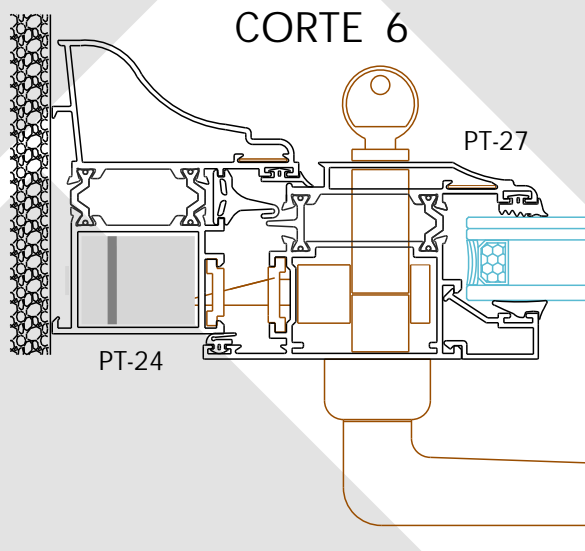
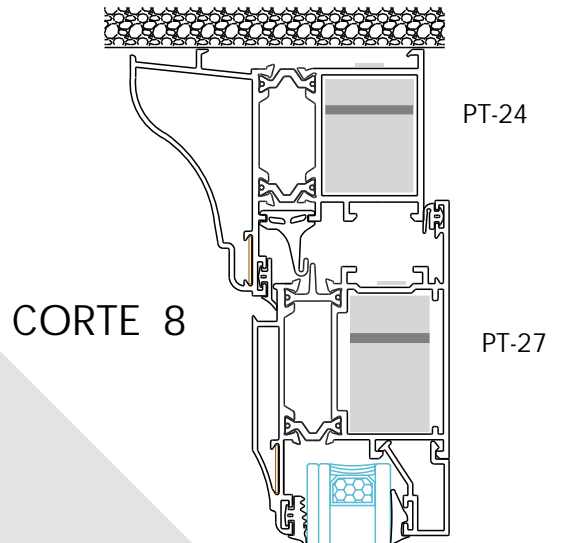
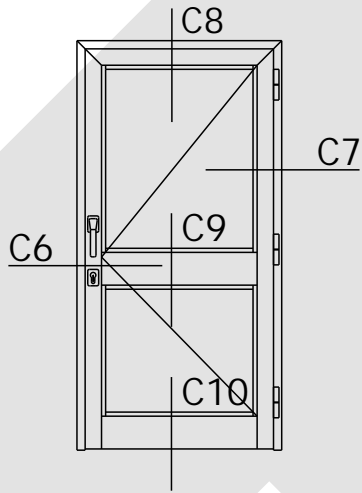

Sem Escala

ed. 001

# RT 45

## PORMENORES DE MONTAGEM

PORTA DE 1 FOLHA OSCILO-PARALELA

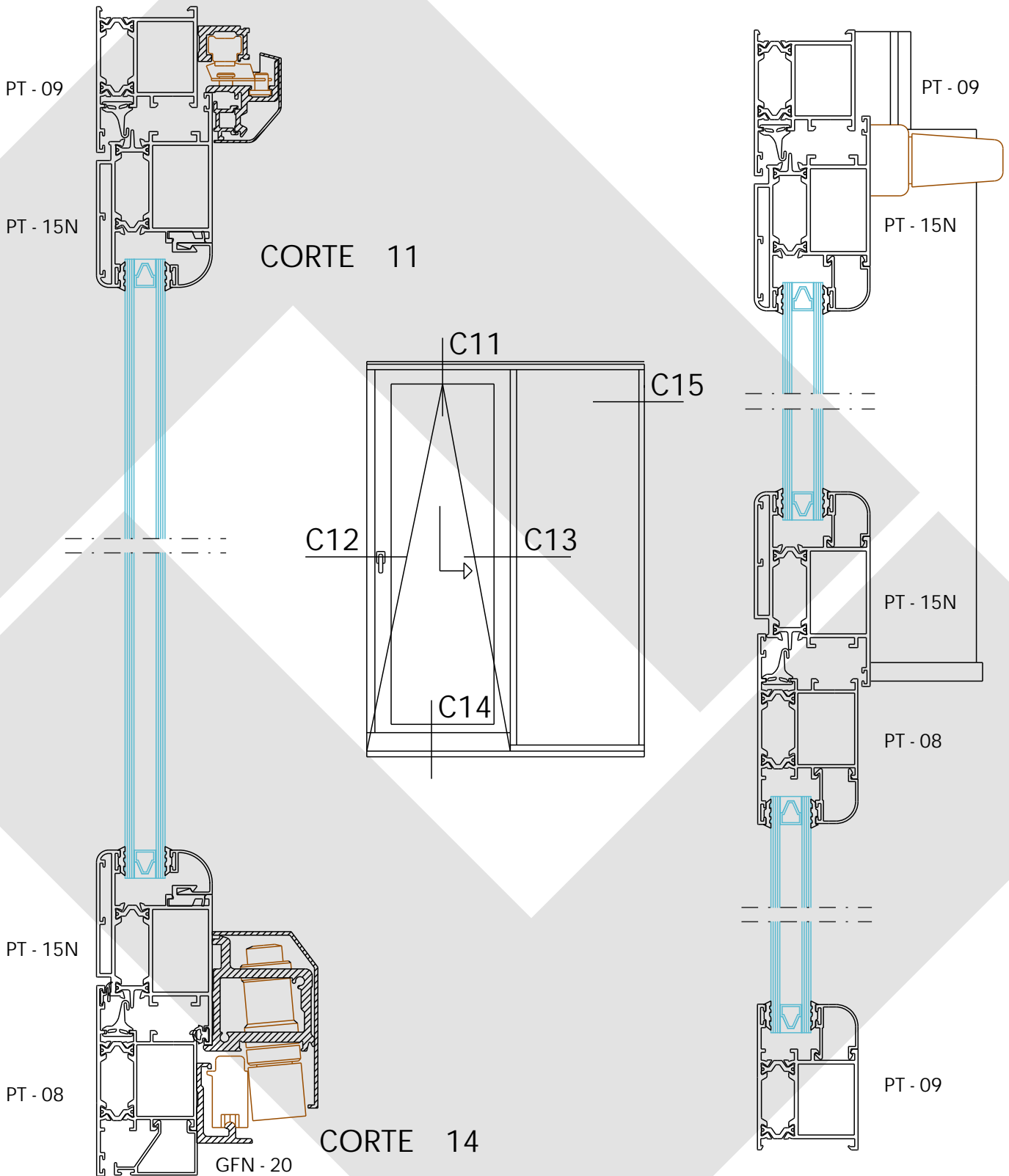

Escala 1:2

# RT 45

## PORMENORES DE MONTAGEM

JANELA DE ABRIR PARA FORA DE 2 FOLHAS

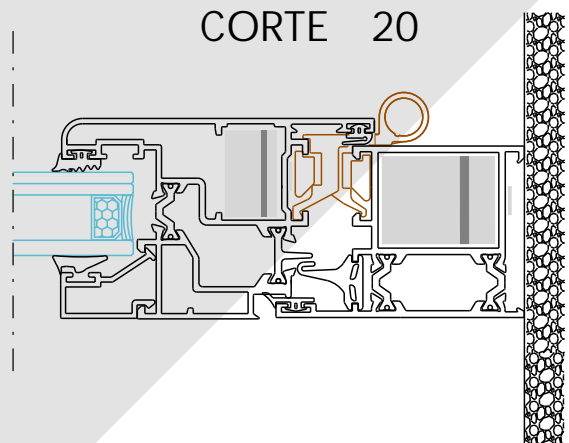
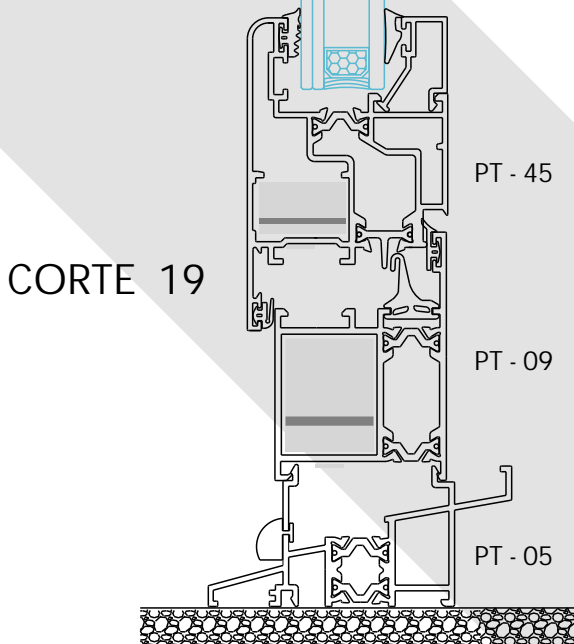
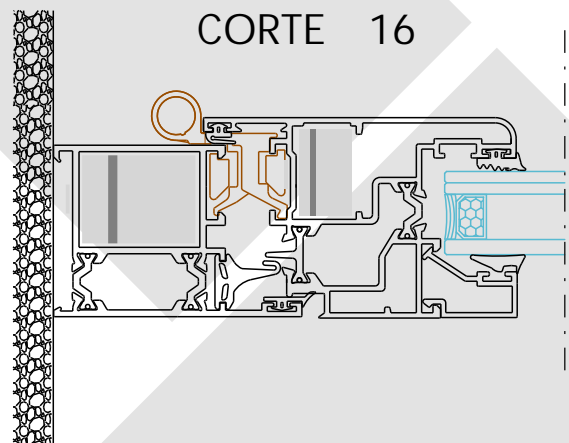
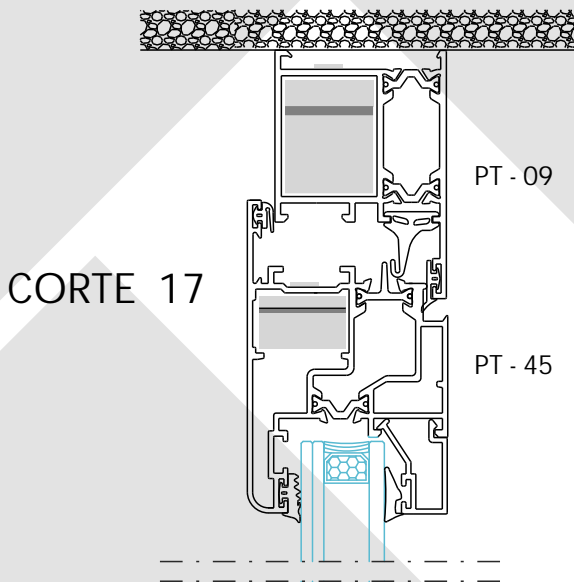
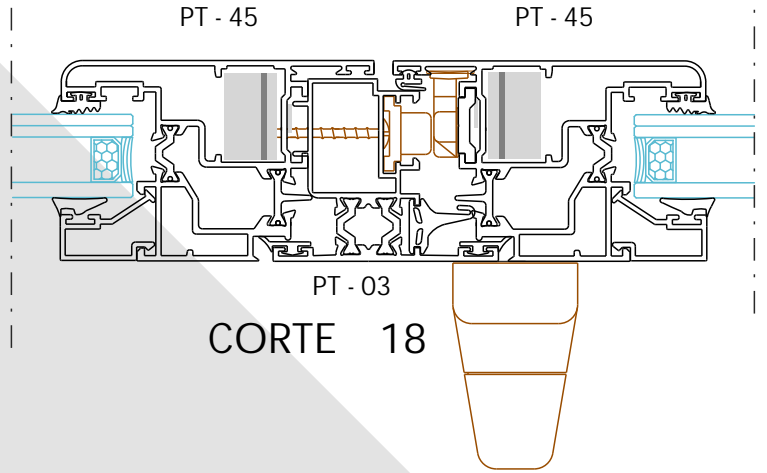
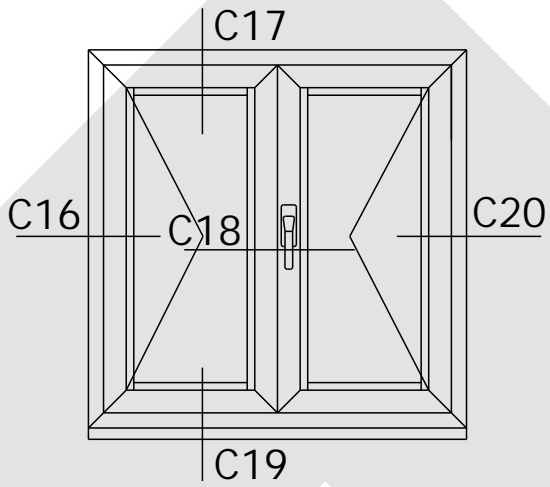

Escala 1:2

ed. 001

## ACESSÓRIOS

### Características

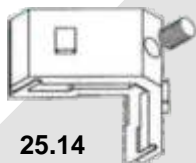

25.14

CÓDIGO **BX.ESQ.04** DESCRIÇÃO: **Esquadro de alumínio injectado**  
 UNID. VENDA: **Unidade** ACABAMENTOS: **Zamak**  
 APLICAÇÃO: **PT-02, PT-06N, PT-25, PT-26**

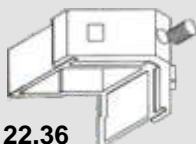

22.36

CÓDIGO **BX.ESQ.03** DESCRIÇÃO: **Esquadro de alumínio injectado**  
 UNID. VENDA: **Unidade** ACABAMENTOS: **Zamak**  
 APLICAÇÃO: **PT-15N, PT-27**



25.31

CÓDIGO **BX.ESQ.07** DESCRIÇÃO: **Esquadro de alumínio injectado**  
 UNID. VENDA: **Unidade** ACABAMENTOS: **Zamak**  
 APLICAÇÃO: **PT-09, PT-24, PT-28, PT-29, PT-90, PT-290**

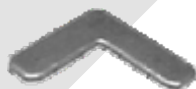

CÓDIGO **BX.AL.INOX** DESCRIÇÃO: **Esquadro de alinhamento**  
 UNID. VENDA: **Unidade** ACABAMENTOS: **Inox**  
 APLICAÇÃO: **PT-06N, PT-15N, PT-41, PT-42, PT-43, PT-45**



CÓDIGO **BX.AL.GFT** DESCRIÇÃO: **Esquadro de alinhamento**  
 UNID. VENDA: **Unidade** ACABAMENTOS: **Zamak**  
 APLICAÇÃO: **PT-06N, PT-15N, PT-41, PT-42, PT-43, PT-45**



CÓDIGO **TOPO GFT** DESCRIÇÃO: **Topo inversor**  
 UNID. VENDA: **Unidade** ACABAMENTOS: **E P D M**  
 APLICAÇÃO: **PT-03C**



CÓDIGO **VD GFT** DESCRIÇÃO: **Vedante central**  
 UNID. VENDA: **Rolo** ACABAMENTOS: **E P D M**  
 APLICAÇÃO: **PT-09, PT-24, PT-28, PT-29, PT-90, PT-290,**



CÓDIGO **VD RT601** DESCRIÇÃO: **Vedante aro fixo**  
 UNID. VENDA: **Rolo** ACABAMENTOS: **E P D M**  
 APLICAÇÃO: **PT-02, PT-09, PT-24, PT-25, PT-28, PT-29, PT-90, PT-290**



CÓDIGO **VD.RT602** DESCRIÇÃO: **Vedante aro móvel**  
 UNID. VENDA: **Rolo** ACABAMENTOS: **E P D M**  
 APLICAÇÃO: **PT-06N, PT-15N, PT-24, PT-25, PT-26, PT-27, PT-42, PT-43**



CÓDIGO **VD.P40** DESCRIÇÃO: **Vedante central**  
 UNID. VENDA: **Rolo** ACABAMENTOS: **E P D M**  
 APLICAÇÃO: **Usar nos aros fixos quando se utilizar os perfis PT-04 e PT-10**